



PRELIMINARY SPECIFICATIONS

WSKY1313Q-5780

WSKY1313Q-5780

SPECIFICATIONS

SEMICON LIGHT 

1. Features

- Chip-Scale-Package LED → Small and thin package
- Package Size - 1.30(L) × 1.30(W) × 0.35(T) mm
- White Emission Package (Top View)
- Ideal for backlighting and coupling in light guides
- Wide view angle ($2\Theta_{1/2}=140\text{deg}$, $\pm 2\text{deg}$)
- CSP to PCB assembly and manufacturing process recommendations

2. Applications

- Lighting or illumination
- SEMICONLIGHT provides a full range of CSPs for your specific application. Each application has its own set of packaging requirements that may vary from the smallest possible size, reliability, long-term footprint/size compatibility, unit cost, total cost, or ease of use. The CSP of choice will vary depending on which packaging requirements are most important to your application.





New Pioneer

We make new world with a new light,
SEMICON LIGHT

1. Scope	4/15
2. Outline Dimensions	4/15
3. Absolute Maximum Ratings	5/15
4. Electro Optical Characteristic	6/15
5. Color Chromaticity Region and Coordinate	7/15
6. Semiconlight CSP Part number	8/15
7. Characteristics Diagrams	9/15
8. Soldering Condition	10/15
9. Packing	11/15
10. Label Structure	12/15
11. Precaution	13/15

Semiconlight co.,ltd

FAB 149, Wongomae-ro 2beon-gil, Giheung-gu, Yongin-si, Gyeonggi-do, Korea

OFFICE 19F, Leaders Tower, 12, Wongomae-ro, Giheung-gu, Yongin-si, Gyeonggi-do, Korea

1. Scope / 2. Outline Dimensions

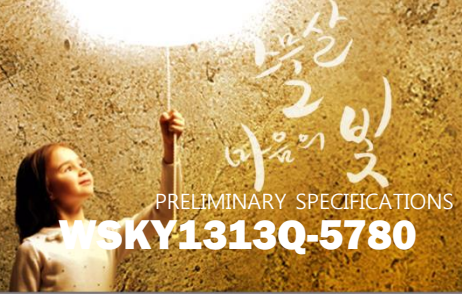

1. Scope

This delivery specification shall apply to the CSP purchased from SEMICONLIGHT Co., Ltd.

2. Outline Dimensions

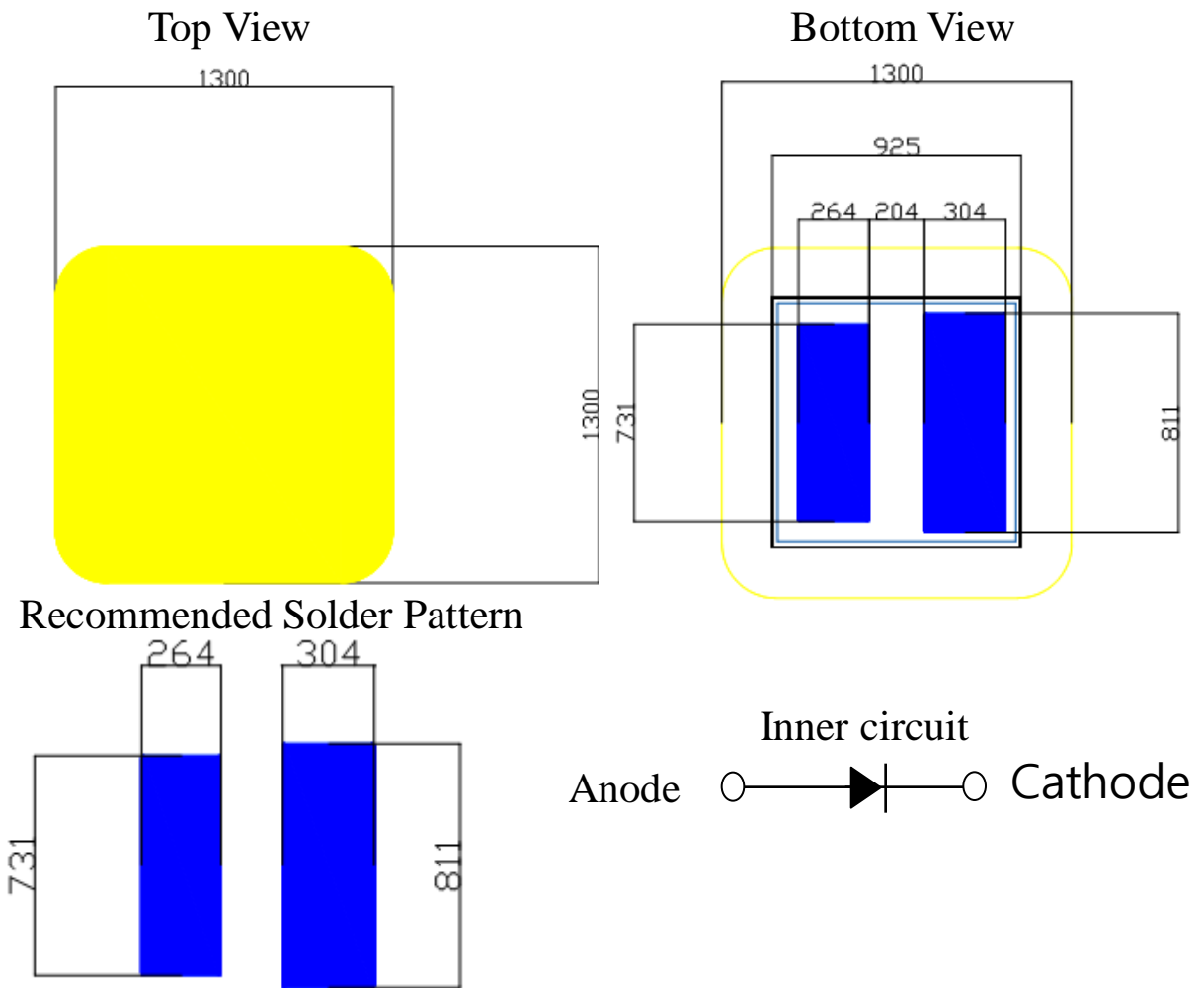

Note

- (1) All dimensions are in micrometer
- (2) CSP outline tolerance $\pm 200\mu\text{m}$
- (3) Solder-pad was terminated Au metal

3. Absolute Maximum Ratings

PRELIMINARY SPECIFICATIONS

WSKY1313Q-5780

Parameter	Symbol	Condition	Unit
Power Dissipation	P_D	2.0	W
Forward Current ⁽¹⁾ [Continuous]	I_F	650	mA
Junction Temperature	T_J	150	°C
Operating Temperature	T_{OPR}	-45 to +85	°C
Storage Temperature	T_{STG}	-45 to +125	°C

Note

(1) 70% point of max peak luminous flux at L-I curve.

4. Electro Optical Characteristics

PRELIMINARY SPECIFICATIONS
WSKY1313Q-5780

1. Luminous Flux Characteristics ($T_a=25^\circ\text{C}$, $I_f=350\text{mA}$)

Product	CCT [K]	CRI	Luminous Flux $\Phi_v(\text{lm})$		
			Code	Min	Max
WSKY1313Q-5780	5,700	80	GI	110	120
			IK	120	130
			KM	130	140

2. Forward Voltage Characteristics ($T_a=25^\circ\text{C}$, $I_f=350\text{mA}$)

Product	Forward Voltage $V_F(\text{V})$		
	Code	Min	Max
WSKY1313Q-5780	bc	2.9	3.0
	cd	3.0	3.1
	de	3.1	3.2

Note

- (1) Correlated Color Temperature is derived from the CIE 1931 Chromaticity diagram.
- (2) SEMICONLIGHT maintains a tolerance of $\pm 7\%$ on luminous flux measurements, ± 3 on CRI.
- (3) Total luminous flux output (Φ_v) as measured with an integrating sphere.
- (4) SEMICONLIGHT maintains a tolerance of $\pm 0.1\text{V}$ on forward voltage measurements.
- (5) SEMICONLIGHT maintains a tolerance of ± 0.005 on chromaticity (CIE_x, CIE_y) measurements.

5. Color Chromaticity Region & Coordinate

PRELIMINARY SPECIFICATIONS

WSKY1313Q-5780

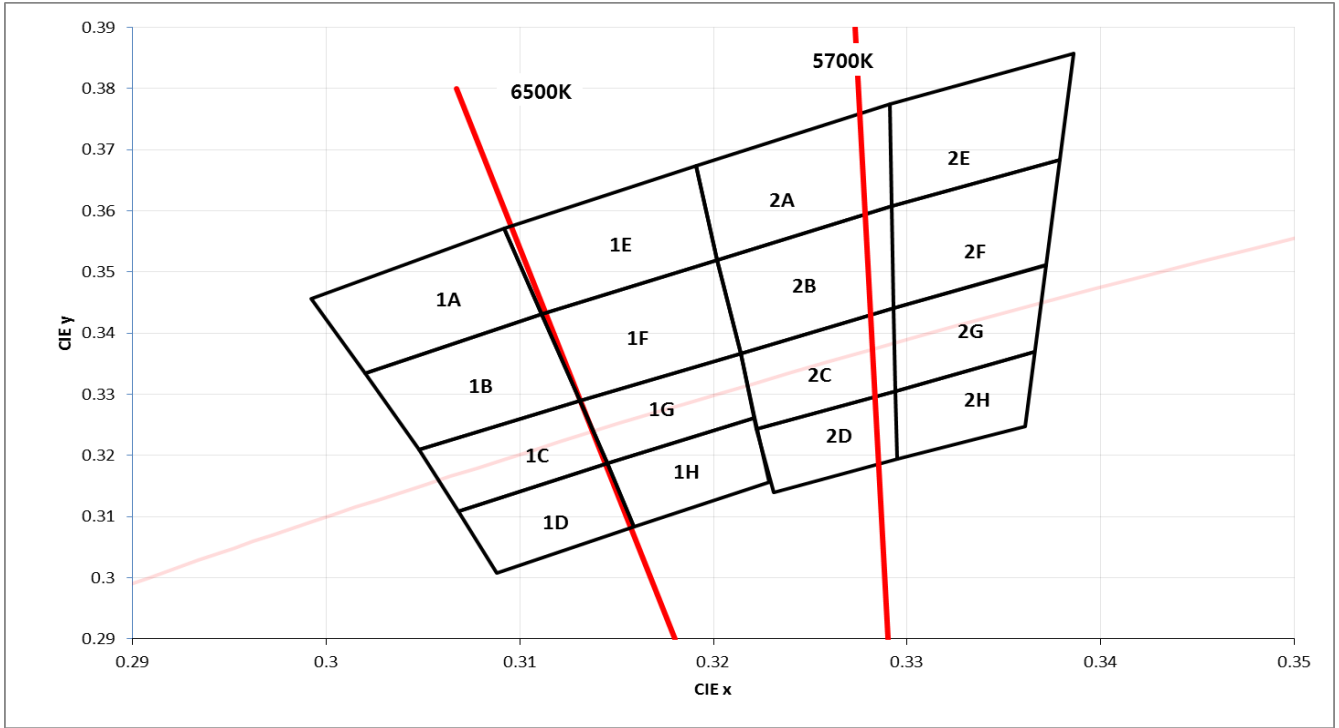

5700 - 6000K

2A		2B		2C		2D	
X	Y	X	Y	X	Y	X	Y
0.3291	0.3775	0.3292	0.3608	0.3293	0.3441	0.3294	0.3305
0.3191	0.3674	0.3202	0.3520	0.3214	0.3366	0.3222	0.3243
0.3202	0.3520	0.3214	0.3366	0.3222	0.3243	0.3231	0.3140
0.3292	0.3608	0.3293	0.3441	0.3294	0.3305	0.3295	0.3194

5300 - 5700K

2E		2F		2G		2H	
X	Y	X	Y	X	Y	X	Y
0.3386	0.3857	0.3379	0.3684	0.3371	0.3511	0.3366	0.3369
0.3291	0.3775	0.3292	0.3608	0.3293	0.3441	0.3294	0.3305
0.3292	0.3608	0.3293	0.3441	0.3294	0.3305	0.3295	0.3194
0.3379	0.3684	0.3372	0.3511	0.3366	0.3369	0.3361	0.3247

6. SEMICONLIGHT CSP Part Number

PRELIMINARY SPECIFICATIONS

WSKY1313Q-5780

Part number for SEMICONLIGHT CSP follow the convention below

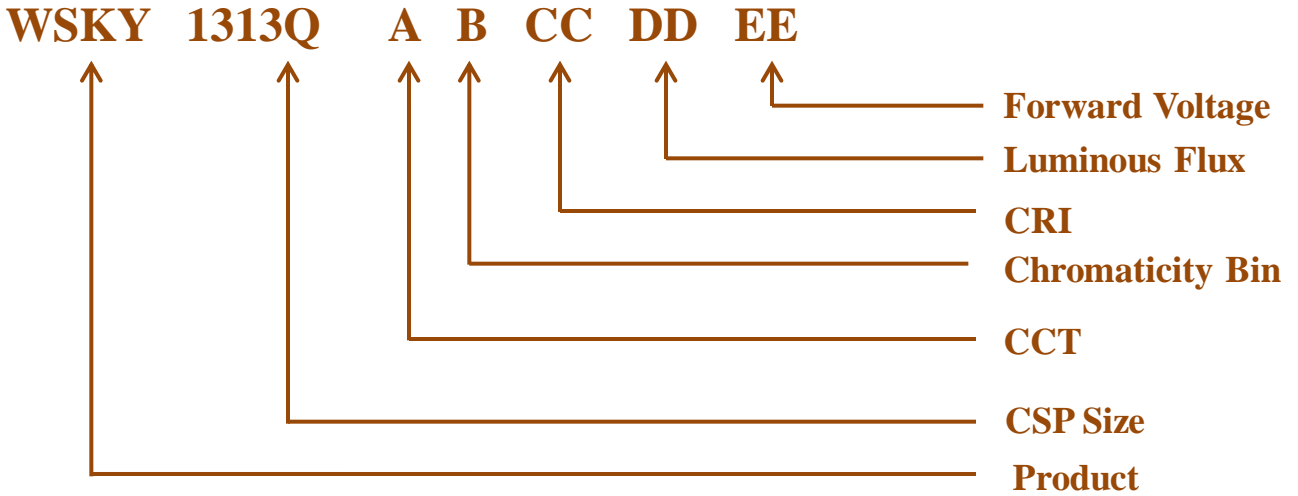

Information		Code	Specification
A	Normal CCT (K)	2	5700
B	Chromaticity Bin	A	E
		B	F
		C	G
		D	H
CC	CRI	80	-
DD	Luminous Flux (Φ_v)	GI	110-120
		IK	120-130
		KM	130-140
EE	Forward Voltage (V)	bc	2.9-3.0
		cd	3.0-3.1
		de	3.1-3.2

7. Characteristics Diagrams

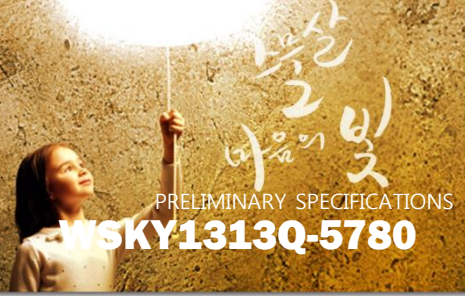

1. Forward Current .vs. Forward Voltage

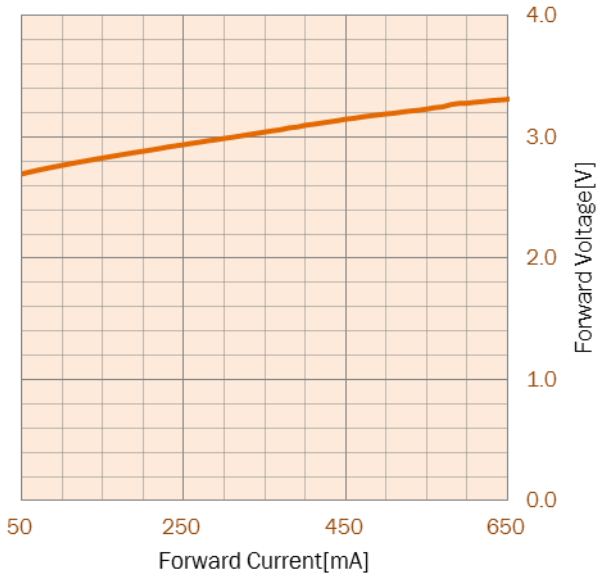

2. Forward Current .vs. Relative Luminous Flux

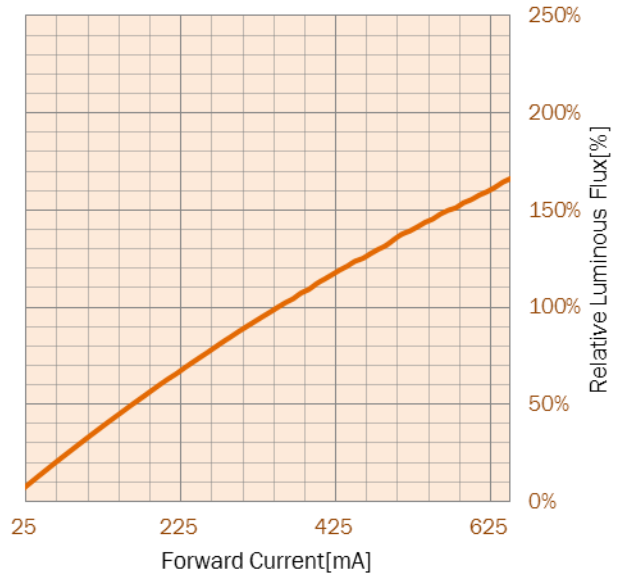

3. Relative Radiant Power .vs. Wavelength

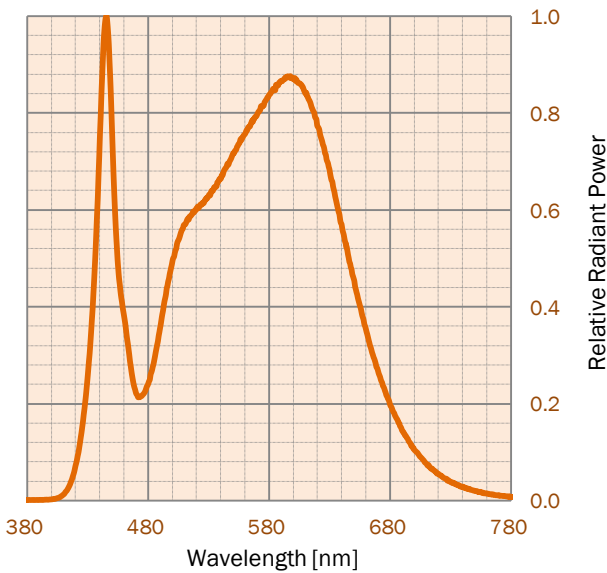

4. Viewing Angle

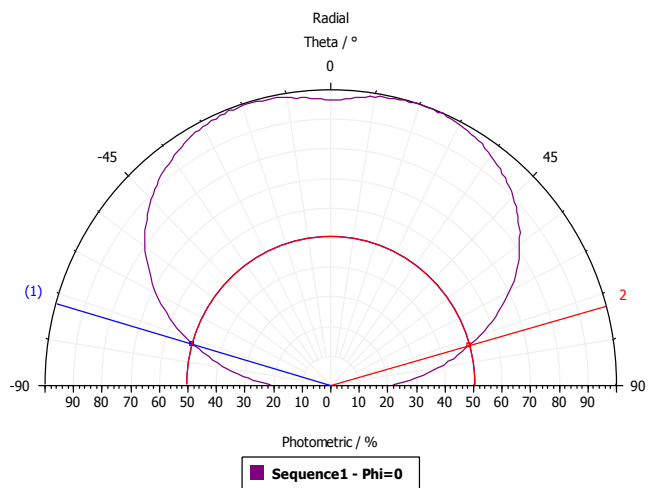

8. Soldering Conditions

PRELIMINARY SPECIFICATIONS

WSKY1313Q-5780

1. Recommended Soldering

- SEMICONLIGHT recommends to use SnAgCu (Tin/Silver/Copper) of solder paste composition.
- The recommended stencil thickness is 60~80 μ m.
- The recommended stencil solder paste area is 60~80%.

2. Soldering Cautions

Reflow soldering should not be done more than two times.

- When soldering, do not put stress on the LEDs during heating.
- After soldering, do not wrap the circuit board.
- The LEDs can be soldered on place using the reflow soldering method.
- Occasionally there is a brightness decrease cause by the influence of heat or ambient atmosphere during air reflow. It is recommend that the user use the nitrogen reflow method.

Effects of the solder conditions on optical characteristics:

- a) Excessive solder or attachment of solder flux on CSP-LED surfaces:
- If solder is protruding from the periphery of the package, total luminous flux might be reduced
 - because of the effect of its shadow. To avoid this, the solder should be controlled to a suitable thickness.
 - The recommended metal mask thickness is 60~80 μ m.

Perform a test to determine the appropriate amount of solder.

Reduction in the reflectance on the PCB surface due to the effect of soldering at excessive temperature:

- b) Discoloration of the PCB surface:

- Soldering at excessive temperature or a solder rework process can reduce the reflectance on the PCB surface, reducing total luminous flux.

10. Label Structure

PRELIMINARY SPECIFICATIONS
WSKY1313Q-5780

Model : WSKY1313Q-5780

Rank : Chromaticity Bin-CRI-Luminous Flux-Forward Voltage

Bin : #Sorting bin number

Reel Lot : Operating date-Bin No.-Operating group-CCT-Operating No.

QTY :

	VF[V]	Flux [lm]	CIE X	CIE Y	CRI
MIN					
AVG					
MAX					
STD					

Note

- (1) Model : Product
- (2) Rank : Consult to page 8
- (3) PCS : Quantity

11. Precaution

PRELIMINARY SPECIFICATIONS
WSKY1313Q-5780

1. Cleaning.

- Flux cleaning should be completed free of residual reactive ion such as Na, Cl, etc. Organic solvent acts upon water and generates corrosive gas such as hydrogen chloride. There are some cases where the device is degraded.
- If cleaning is required, IPA is recommended as cleaning solution.

2. Mounting Precautions

- Do not apply mechanical stress to the CSPs body (phosphor) at high temperature.
- The time taken for a device to return to the room temperature after reflow soldering depends on the mounting board and environmental conditions.
- The CSPs do not contain ESD protection device .(ex. zener diode)
- Pressure on the CSPs will influence to the reliability and easily scratched. Avoid friction against hard materials and strong pressure.
- It is recommend, do not put stress on the CSPs during heating .
- When installing an assembled board into equipment, ensure that the devices on the board do not contact with other components.
- Recommend once soldering. If re-soldering can not avoid, The CSPs characteristics should be carefully checked before and after such repair.

3. Packing

- Moisture-Proof Packaging
- These LED devices are packed in an aluminum envelope with a silica gel and a moisture indicator to avoid moisture absorption. The optical characteristics of the device may be affected by exposure to moisture in the air before soldering and the device should therefore be stored under the following conditions:
- This moisture proof bag may be stored unopened within 12 months at the following conditions.
- Temperature: 5 °C to 30 °C Humidity: 90 % (max)
- After opening the moisture proof bag, the device should be assembled within 4 weeks in an environment of 5 °C to 30 °C/60 % RH or below.

11. Precaution

PRELIMINARY SPECIFICATIONS
WSKY1313Q-5780

4. Handling Precautions

- The tape is antistatic-coated. However, if the tape is charged with excess static electricity, devices might cling to the tape or waggle in the tape when the cover tape peeled off. Be aware of the following to avoid this:
- Use an ionizer to neutralize the ions when utilizing an automatic mounter.
- For transport and temporary storage of devices, use containers (boxes, jigs, bags) that are made with antistatic materials or materials that dissipate static electricity.

5. Measuring Precautions

- CSPs do not contain a Zener diode for ESD protection.
- Use preventive (ESD, EOS) measure; conductive floor mats, ground connection, wear conductive shoes, and wear a wrist strap
- Take suitable preventive measures according to your working environment
- Note that the above measures are only examples
- When the device is in operation, the forward current should be carefully determined considering the maximum ambient temperature and corresponding junction temperature.

6. Manual Handling Precaution

- Do not pick up CSPs with your fingers.
- The horizontal or vertical force applied to the CSPs might damage.
- Use tweezers to pick up CSPs.
- Do not push or pull CSPs surface.
- Do not hold CSPs in vertical direction.
- Recommend holding the sidewalls of the CSPs
- Recommend using ESD protected or vacuum tweezers.

7. Manual Handling Precaution ; Assembled PCB with CSPs

- Do not stack PCBs to avoid any direction load on CSPs.
- If excessive mechanical force applied to the CSPs, cause a peel or crack in phosphor.
- Recommend to keep at least 4-5mm spacing between nearby PCBs.
- Prevent any force from being applied directly to the CSPs.
- When Attaching a heat sinks to the assembled PCBs
- Do not press CSPs directly with any tools or your fingers

11. Precaution

8. Others

If the forward or reverse voltage which exceeds the absolute maximum rating is applied to the LEDs, that will cause the damage to the LEDs. It is possible that the damaged LEDs .Be careful not to look the LEDs that the output power is strongly increased in the face. It is possible that eyesight has been getting weaker.

This specifications of the product may be revised without notice.

9. Precaution Manual Handling Precaution

1. Do not pick up CSPs with fingers.

- The horizontal or vertical force applied to the CSPs might damage.

2. Use tweezers to pick up CSPs.

- Recommend using ESD protected or vacuum tweezers.

3. Precaution to be taken for use of tweezers.

- Do not push or pull CSPs surface.
- Do not hold CSPs in vertical direction.
- Recommend holding the sidewalls of the CSPs

10. Precaution Manual Handling Precaution : Assembled PCB with CSPs

1. Do not stacks PCBs to avoid any direction load on CSPs.

- If excessive mechanical force applied to the CSPs, cause a peel or crack in phosphor.
- Recommend to keep at least 4-5mm spacing between nearby PCBs.
- Prevent any force from being applied directly to the CSPs.

2. When Attaching a heat sinks to the assembled PCBs

- Do not press CSPs directly with any tools or your fingers